

DOT-X

Displays by Dotronix

DNR V SERIES DISPLAY 27 inch



DOT-X
Displays by Dotronix
160 FIRST STREET S.E.
ST. PAUL, MN 55112-7894
PHONE 651-633-1742
FAX: 651-633-1065
www.dotronix.com

User's Manual

PRECAUTIONS

This monitor contains circuits and components designed to meet specific performance and safety requirements. No component changes may be made without the written permission of the manufacturer.

To prevent electrical shock, do *not* attempt to disassemble the monitor. There are no user-serviceable parts inside. Servicing, if required, should be performed only by qualified service technicians familiar with the equipment and safety procedures. **Servicing by unauthorized personnel may be dangerous and will void the warranty.**

Do not use this monitor beyond its temperature and humidity range. This unit is designed for indoor use. Ambient temperature range must not be above 113°F or below 32°F. Avoid using this monitor when the humidity is either above 95% or less than 5%. Do not block the ventilation slots on the rear side of the monitor. Allow for normal ventilation.

Position the monitor to avoid direct sunlight on the picture tube. Generally, adjust the monitor for proper lighting and monitor position to minimize undesirable reflections.

All rights reserved. No part of this publication may be reproduced, stored in a retrieval system, or transmitted, in any form or by any means, mechanical, photocopying, recording or otherwise, without the prior written permission of Dotronix, Inc. No patent liability is assumed with respect to the use of the information contained herein. Where every precaution has been taken in the preparation of this manual, Dotronix, Inc. and the author assume no responsibility for errors or omissions. Neither is any liability assumed for damage resulting from the use of the information contained herein.

Specifications are subject to change due to technological progress.

© Copyright 2001, Dotronix, Inc.
Publication No.01083 Rev. A
160 First Street S.E.
St. Paul, MN 55112-7894, USA

Dotronix Limited Warranty

Dotronix warrants that for one (1) year from date original purchase, it will, at its option, repair, replace or refund the purchase price of any product which it manufactured that proves defective in material or workmanship in normal use and service.

To obtain service under this Warranty, contact Dotronix Inc. at the address below, within one (1) year of original purchase, to receive a Return Material Authorization (RMA) number. Then ship the product believed to be defective, transportation prepaid, for inspection.

Dotronix shall not be responsible for unauthorized returns that do not list the RMA number and quantity returned on the outside of the shipping container (i.e. on packing list in plain view).

For products supplied without a frame (Less CRT and Printed Circuit Board Mounting), the buyer must inspect the products within ten (10) days of receipt. After ten (10) days have lapsed, there shall be no warranty coverage for broken or damaged parts, or misalignment (i.e. broken torque seals where used). The products will be packed to allow Buyer to test the unit within its packing carrier.

This Warranty applies only to goods manufactured by Dotronix Inc. Various component parts manufactured by others (such as cathode ray tubes, semi-conductors, and fuses) are covered by the separate warranty of their manufacturers. Where Dotronix, Inc. warranty differs, only the warranty of the original component part manufacturer is offered. Of course, the Dotronix warranty does not apply to CRT's that are scratched, broken, burned or have imperfections in any special coatings. It also does not apply to products which have been altered, damaged, abused, or subjected to misuse, or repaired by anyone other than an authorized Dotronix repair person.

These displays require DHHS traceability under sub-part E, Section 1002.40 of the Regulations for the Administration and Enforcement of the Radiation Control for Health and Safety Act of 1968. It is the customer's responsibility to maintain records that satisfy this requirement.

THE TERMS OF THIS WARRANTY CONSTITUTES THE BUYER'S SOLE AND EXCLUSIVE REMEDY AGAINST DOTRONIX. THERE IS NO IMPLIED WARRANTY OF MERCHANTABILITY OR FITNESS FOR A PARTICULAR PURPOSE. UNDER NO CIRCUMSTANCE SHALL DOTRONIX BE LIABLE FOR INCIDENTAL AND CONSEQUENTIAL DAMAGES, OR IN ANY AMOUNT BEYOND THE REPLACEMENT COST OF THE ALLEGEDLY DEFECTIVE PART, REGARDLESS OF THE THEORY OF RECOVERY.

All products returned to Dotronix must include:

1. A tag or label on each unit with a description of the defect or reason for return, or identify each unit on the packing list by serial number and defect.
2. A packing list attached to the outside of the shipping container showing the Return Authorization Number (RMA) and the quantity returned.

Products returned that are not identified in accordance with the above procedure will be refused and returned at Buyer's expense.

To obtain a Return Material Authorization (RMA) number contact:

DOTRONIX INC.
160 First Street S.E. • St. Paul • Minnesota • 55112-7894
Phone 651-633-1742 • FAX 651-633-1065

INDEX

AVAILABLE MENUS	16
BASIC MENU OPERATION	16
CRT COATINGS OPTION	13
GETTING STARTED	8
IMPORTANT SAFETY INSTRUCTIONS	3
INTRODUCTION	8
MECHANICAL DIMENSIONS-CUBE	10
MENU-AVAILABLE	16
MENU-BASIC OPERATION	16
MENU-SERVICE	17
PRECAUTIONS	2
REAR CONTROLS	11
REGULATORY NOTICES	7
REMOTE CONTROL	15
SAFETY WARNINGS	3
SERVICE MENU	17
SERVICE MODULE INPUT	14
SETUP MENU	12
SPECIFICATIONS	9
WALL INSTALLATIONS	12
WARRANTY, DOTRONIX LIMITED	23

SAFETY WARNINGS



WARNING

RISK OF ELECTRIC SHOCK

DO NOT OPEN



WARNING:

TO REDUCE THE RISK OF ELECTRIC SHOCK, DO NOT REMOVE COVER OR BACK. NO USER SERVICEABLE PARTS INSIDE. REFER TO QUALIFIED SERVICE PERSONNEL.

The lightning flash with arrowhead symbol within an equilateral triangle is intended to alert the user to the presence of uninsulated “dangerous voltage” within the product’s enclosure that may be of sufficient magnitude to constitute a risk of electric shock to persons.

The exclamation point within an equilateral triangle is intended to alert the user to the presence of important operating and maintenance (servicing) instructions in the literature accompanying the appliance.

SAFETY TIPS

Refer to the “Important Safety Instructions” section of this operating guide for important safety considerations.

WARNING

TO PREVENT FIRE OR SHOCK HAZARDS, DO NOT EXPOSE THIS PRODUCT TO RAIN OR MOISTURE.

NOTE TO CABLE TV SYSTEM INSTALLER

This reminder is provided to call the cable TV system installer’s attention to Article 820-40 of the National Electrical Code (U.S.A.). The code provides guidelines for proper grounding and, in particular, specifies that the cable ground shall be connected to the grounding system of the building, as close to the point of the cable entry as practical.

IMPORTANT SAFETY INSTRUCTIONS

Your product has been manufactured and tested with your safety in mind. However, improper use can result in potential electrical shock or fire hazards. To avoid defeating the safeguards that have been built into your new product, please read and observe the following safety points when installing and using your new product, and save them for future reference. Observing the simple precautions discussed in this section of the operating guide can help you get many years of enjoyment and safe operation from your new product.

1. Read Instructions

Read all the safety and operating instructions before operating the product.

SAFETY WARNINGS

2. Follow Instructions

Follow all operating and use instructions.

3. Retain Instructions

Keep the safety and operating instructions for future reference.

4. Heed Warnings

Follow all warnings on the product and in the operating instructions.

5. Cleaning

Unplug this product from the wall outlet before cleaning. Do not use liquid cleaners or aerosol cleaners. Use a damp cloth for cleaning.

6. Water and Moisture

Do not use this product near water—for example, near a bath tub, wash bowl, kitchen sink, laundry tub, in a wet basement, or near a swimming pool.

7. Accessories

Do not place this product on an unstable cart, stand, tripod, bracket, or table. The product may fall, causing serious injury to a child or adult, and serious damage to the product. Use only with a cart, stand, tripod, bracket, or table recommended by the manufacturer or sold with the product. Any mounting of the product should follow the manufacturer's instructions, and should use a mounting accessory recommended by the manufacturer.

8. Transporting Product

Move product and cart combinations with care. Quick stops, excessive force, and uneven surfaces may cause the product and cart combination to overturn.



PORTABLE CART WARNING

9. Attachments

Do not use attachments not recommended by the product manufacturer as they may cause hazards.

10. Ventilation

Slots and openings in the cabinet must not be blocked or covered. They are provided for ventilation, to ensure reliable operation, and to protect from overheating. Never block the openings by placing the product on a bed, sofa, rug or other similar surface. This product should not be placed in a built-in installation such as bookcase or rack unless proper ventilation is provided or the manufacturer's instructions have been adhered to.

11. Power Source

Operate this product only from the type of power source indicated on the marking label. If you are not sure of the type of power supply to your home, consult your product dealer or local power company. For products intended to operate from battery power or other sources, refer to the operating instructions.

enabled and when Campport connector plug is detected the display will change to the Campport source. Range is 0-1.

59 ACK MASK: Not used.

60 POLL RATE: Select Poll rate for MPI communications. Range is 20-169.

61 TIMING PULSE: Select timing pulse for MPI communications. Range is 186-227.

62 DIS. SETUP M: Disable/Enable displaying Setup Menu . Range 0-1.

63 DIS. AUDIO M: Disable/Enable displaying Audio Menu. Range 0-1.

64 DIS. VIDEO M: Disable/Enable displaying Video Menu. Range 0-1.

65 DIS. PARENTAL M: Disable/Enable displaying Parental. M. Range 0-1.

66 CH -TIME: Disable/Enable displaying CH TIME. Range 0-1.

67 EN. SET. COL: Disable/Enable custom colors for Setup Menu. Range 0-1

68 EN. AUD. COL: Disable/Enable custom colors for Audio Menu. Range 0-1.

69 EN. VID. COL: Disable/Enable custom colors for Video Menu. Range 0-1.

70 EN. PTL. COL: Disable/Enable custom colors for Parental Menu. Range 0-1.

71 EN. CH-T COL: Disable/Enable custom colors for CH TIME. Range 0-1.

72 FOR. SETUP M.: Select between (0 to 7) to set foreground color for Setup Menu.

Menu colors: 0-Black, 1- Red, 2- Green, 3- Yellow, 4- Blue, 5- Magenta, 6- Cyan, 7 White

73 FOR. AUDIO M.: Select between (0 to 7) to set foreground color for Audio Menu.

74 FOR. VIDEO M.: Select between (0 to 7) to set foreground color for Video Menu.

75 FOR PTL M.: Select between (0 to 7) to set foreground color for Parental Menu.

76 FOR CH-TIME: Select between (0 to 7) to set foreground color for Ch-Time.

77 BCK. SETUP M.: Select between (0 to 7) to set background color for Setup Menu.

78 BCK. AUDIO M.: Select between (0 to 7) to set background color for Audio Menu.

79 BCK. VIDEO M.: Select between (0 to 7) to set background color for Video Menu.

80 BCK. PTL M.: Select between (0 to 7) to set background color for Parental Menu.

81 BCK. CH-TIME: Select between (0 to 7) to set background color for Ch-Time.

Underlined commands are used most often.

35 RF AGC: (Rf Automatic Gain Control) Range is from 0- 63. 48 is a general setting. Tune in weakest available channel and adjust for a snow-free picture.

36 HORZ AFC: Range is 0-1. Set to 0. 0=AFC2 Normal. 1=AFC2 X 3.

37 WHITE COMPRESS: (White Compression) The range is 0 to 1. Set to 0. 0 = Enable and 1 = Disable.

38 60HZ SW: (60 Hertz Switched) The range is 0 to 2.

39 PIF VCO: (PIF Voltage Controlled Oscillator) . Range is 0-127.

40 RED CUT: B&W tracking adjustment. Range is 0-254. Typical value is 20.

41 GREEN CUT: B&W tracking adjustment. Range is 0-254. Typical value is 0.

42 BLUE CUT: B&W tracking adjustment. Range is 0-254. Typical value is 28.

43 GREEN GAIN: B&W tracking adjustment. Range is 0-254. Typical value is 45.

44 BLUE GAIN: B&W tracking adjustment. Range is 0-254. Typical value is 70.

45 6 KEY SYSTEM: Keyboard type. Set to 1 for 6 key and 0 for 10 key. Range 0-1.

46 A ATT: Audio Attenuation adjustment.

47 A VCO: (Voltage-Controlled Oscillator) range is 0-63. Typical value range 10-39.

48 A FILTER: (Second Audio Program Voltage-Controlled Oscillator) Stereo, SAP, and dBx filter adjustment. Range is from 0-63.

49 A SPECTRL: Adjustment of stereo separation (3kHz). Range is 0-63.

50 WIDE BAND: Adjustment of stereo separation (300kHz). Range is 0-63.

51 MAX BLK HRS: Determines the maximum block hours that V-chip could be programmed. Range is 0-99.

52 STRT CH SM: Enable start channel at scan mode. Range is 0-1.

53 RADIO: Enable or disable the access to radio function.

54 AUX: Enables the access to auxiliary input.

55 VCHIP: Enable the V Chip Function.

56 MUTE DISABLE: If it is enabled (set to 1) it disables the functionality of the Mute Key.

57 EN LA7222: Used in Conceirge Models to enable separate auxiliary inputs (Campport and Rear Auxiliary)

58 AUTO CAMPOR: Enable Campport sense. When in 1 Campport sense is

20

SAFETY WARNINGS

12. Line-Cord Polarization

This product is equipped with a polarized alternating-current line plug (a plug having one blade wider than the other). As a safety feature, this plug will fit into the power outlet only one way. If you are unable to insert the plug fully into the outlet, try reversing the plug. If the plug still fails to fit, contact your electrician to replace your obsolete outlet. Do not defeat the safety purpose of the polarized plug.

Alternate Warnings-This product is equipped with a three-wire grounding-type plug, a plug having a third (grounding) pin. This plug will only fit into a grounding-type power outlet. This is a safety feature. If you are unable to insert the plug into the outlet, contact your electrician to replace your obsolete outlet. Do not defeat the safety purpose of the grounding-type plug.

13. Power-Cord Protection

Route power supply cords so that they are not likely to be walked on or pinched by items placed upon or against them, paying particular attention to cords at plugs, convenience receptacles, and the point where they exit from the product.

14. Outdoor Antenna Grounding

If an outdoor antenna or cable system is connected to the product, be sure the antenna or cable system is grounded so as to provide some protection against voltage surges and built-up static charges. Article 810 of the National Electrical Code (U.S.A.), ANSI/NFPA 70 provides information with regard to proper grounding of the mast and supporting structure, grounding of the lead-in wire to antenna discharge unit, connection to grounding electrodes, and requirements for the aroundina electrode.

EXAMPLE OF GROUNDING ACCORDING TO NATIONAL ELECTRICAL CODE INSTRUCTIONS

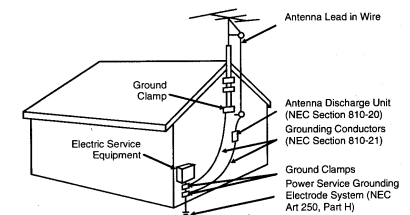

NEC - NATIONAL ELECTRICAL CODE

15. Lightning

For added protection for this product (receiver) during a lightning storm, or when it is left unattended and unused for long periods of time, unplug it from the wall outlet and disconnect the antenna or cable system. This will prevent damage to the product due to lightning and power-line surges.

16. Power Lines

An outside antenna system should not be located in the vicinity of overhead power lines or other electric light or power circuits, or where it can fall into such power lines or circuits. When installing an outside

SAFETY WARNINGS

antenna system, take extreme care to keep from touching such power lines or circuits, as contact with them might be fatal.

17. Overloading

Do not overload wall outlets and extension cords, as this can result in risk of fire or electric shock.

18. Objects and Liquid Entry

Never push objects of any kind into this product through openings, as they may touch dangerous voltage points or short-out parts that could result in a fire or electric shock. Never spill liquid of any kind on the product.

19. Servicing

Do not attempt to service this product yourself, as opening or removing covers may expose you to dangerous voltage or other hazards. Refer all servicing to qualified service personnel.

20. Damage Requiring Service

Unplug this product from the wall outlet and refer servicing to qualified service personnel under the following conditions:

- a. If the power supply cord or plug is damaged.
- b. If liquid has been spilled, or objects have fallen, into the product.
- c. If the product has been exposed to rain or water.
- d. If the product does not operate normally by following the operating instructions. Adjust only those controls that are covered by the operating instructions; improper adjustment of other controls may result in damage and will often require extensive work by a qualified technician to restore the product to its normal operation.
- e. If the product has been dropped or the cabinet has been damaged.
- f. If the product exhibits a distinct change in performance.

21. Replacement Parts

When replacement parts are required, be sure the service technician has used replacement parts specified by the manufacturer or that have the same characteristics as the original part. Unauthorized substitution may result in fire, electric shock, or other hazards.

22. Safety Check

Upon completion of any service or repairs to this product, ask the service technician to perform safety checks to determine that the product is in proper operating condition.

23. Wall or Ceiling Mount

Mount the product to a wall or ceiling only as recommended by the manufacturer.

24. Heat

Keep the product away from heat sources such as radiators, heat registers, stoves, or other products (including amplifiers) that produce heat.

scan. In scan modes 1,3 the power On/Off could be changed with Start Ch SM=1 Factory items and Start channel.

Scan Mode Characteristics

0 AUX, TV, VCR3, VCR4	2 AUX, TV, VCR3, VCR4, FM
1 AUX, TV, VCR3, VCR4, ON/OFF	3 AUX, TV, VCR3, VCR4, FM, ON/OFF

17 TEXT MODE: Turns text mode on or off in the users menu. Range is 0-1. Zero is off and one is on. In on mode, user can call up text mode. Set to 0 unless text is being used.

18 SLEEP TIMER: Enables sleep timer key. Range is 0-1. Zero is off and 1 is on.

19 ALARM: Enables Alarm Key. Range is 0-1. Zero is off and 1 is on.

20 CH OVER RIDE: Zero is off, one is on. In on mode, the display works normally. This item is generally set to off so it can be controlled with entertainment unit. In off mode, Auto Program and Channel Add/Delete do not function.

21 OLD OCV: (On Command Video) Not used.

22 CAPTION LOCK: Zero is off, 1 is on. Set to 1 for operation to restore previous on/off state after display is initially turned on.

23 FUNCTION PRE: (Function Menu Channel Preview) Range is 0-1. Zero is off and one is on. Set to 1 to suppress channel preview screen in the function menu for some pay per view systems.

24 FEATURE LEVEL: Not used.

25 TRAP 3.58: Zero is off, one is on. Set to 1 for normal display operation. Set to 0 if Y/C is used or chassis has a comb filter.

26 RF BAND PASS: Sets adjustment range of the customer control for brightness in therefore mode. Range is 0-1. Set to 1.

27 RF BRT: (RF brightness) Sets adjustment range of customer control for brightness in RF mode. Range is 0-63. A typical value is 30.

28 AUX BRT: (Auxiliary Brightness) Sets adjustment range of the customer control for brightness in AUX mode. Range is 0-63. Typical value is 30.

29 MAX CONTRAST: Sets adjustment range of customer control for contrast. Range is 0-63. Typical value is 63.

30 VERT SIZE: (Vertical Size) Range is 0-254.

31 HORZ SIZE: (Horizontal Size) Range is 0-254.

32 VERT PHASE: (Vertical Phase) Range is 0-7.

33 HORZ PHASE: (Horizontal Phase) Range is from 0-31.

34 AUDIO LEVEL: Sound Attenuation range is 0-63.

03 POWER MANAGE: Range is 0-7. 1-7 is the length of time (in hours) that the set will continue to operate if unattended. When the set nears turn off time, an on-screen message appears telling you to press any key to continue normal viewing. When set to 0, this feature is inactive.

04 VERT POS: Moves On-Screen Displays vertically. The Range is from 0-25. This adjustment is generally set at 5.

05 HORZ POS: Moves On-Screen Displays horizontally. Range is from 1-15. Generally set at 9.

06 BAND/ AFC: There are eight positions:

0 is Broadcast fixed	2 is HRC afc	4 is Broadcast afc	6 is HRC fixed
1 is CATV afc	3 is ICC afc	5 is CATV fixed	7 is ICC fixed

07 MIN VOLUME: Allows adjustment of minimum volume level. Range is 0-63. When this item is set to 0, the sound level can be adjusted down to zero.

08 MAX VOLUME: Allows the adjustment of maximum volume level. Range is 0-63. When this item is set to 63, the set has full adjustment capability.

09 AC ON: Has two positions; 0 is off, and 1 is on. In ON position, the display set will turn on and off when AC power is applied.

10 KEY DEFEAT: Prevents the end user from accessing screen menus on the front panel (Menu, Select, Adjust), only can be accessed by the Menu in the remote control.

11 STRT CH: Determines the channel that is selected automatically each time the display is turned on and sets the audio volume level at turn-on. Range is 0-255. 0 is the Aux position and 255 is Off. Use ADJUST to change the channel number.

12 STRT VOL: Determines the volume that is selected automatically each time the display is turned on and sets the audio volume level at turn-on. Range is 0-255. 0 is the Aux position and 255 is off.

13 HOSPITAL MODE: The default is 0 for Concierge and 1 for Hospital Models. If it is 1 the Private IR codes are selected. Used with feature level to select IR code type. Range is 0-2.

14 CHAN LOCK: Defeats tuning operations. Range is 0-1. 0 is Off and 1 is On. In combination with the START channel, it can lock-on a particular channel

15 GHOST CH: Ghost channel when item #11 is set to zero. Zero is off and 1 is on. When on, the channel number will stay on screen at all times, unless captions are present. The number moves slightly to prevent damage to the screen. If captions are on, ghost channel will not be present.

16 SCAN MODE: Range is 0-3. The sets turn off when channel scan buttons are being used. In 0 mode, scan off is inoperative. In position 1, the set will turn off between auxiliary and lowest channel. In position 2, the set will turn off between auxiliary and FM. In position 3, the set turns off after an FM station

REGULATORY NOTICES

DHHS: This product complies with applicable DHHS Standards under the Radiation Control for Health and Safety Act of 1968.

X-Ray Precaution: This product includes critical electrical parts essential for X-radiation protection. Under *no* circumstances should the operator attempt to disassemble or modify the display.

WARNING: Changes or modifications not expressly approved by the party responsible for compliance with the FCC's rules (The FCC "Grantee") could void the user's authority to operate this equipment.

NOTE: This equipment has been tested and found to comply with the limits for a Class A digital device, following Part 15 of the FCC Rules. These limits are designed to provide reasonable protection against harmful interference when the equipment is operated in a commercial environment. This equipment generates, uses, and can radiate radio frequency energy and if not installed and used in accordance with this operation manual, may cause interference to radio communications. Operation of this equipment in a residential area is likely to cause harmful interference, in which case the user will be required to correct the interference at his or her own expense.

If necessary, the user should consult an experienced radio/television technician for additional suggestions. The user may find the following booklet prepared by the Federal Communications Commission helpful:

"How to Identify and Resolve Radio-TV Interference Problems"

This booklet is available from the U.S. Government Printing Office, Washington, DC 20402, Stock No. 004-000-00345-4.

It is necessary to use shielded interconnect cable with this monitor to insure compliance with FCC Class A limits for radio frequency emissions.

INTRODUCTION

Congratulations on your purchase of a new DNR V Series 27 inch Display.

This manual has been prepared to act as a guide in the operation of your monitor. Please read the following operating instructions carefully before using your monitor so that you are familiar with all of its features and capabilities. All precautions and safety warnings should be read and strictly observed.

UNPACKING THE MONITOR

To unpack your monitor:

1. Untape and open the top flaps of the packing carton. The monitor will be cushioned by foam inserts. The back of the monitor will be facing up.
2. With the top open, carefully roll the monitor carton so the top of the box is positioned down. Remove the monitor by lifting the box up and off the monitor and the inserts. **Caution:** A firm hold on the monitor must be constantly maintained while it is being removed from its packing carton.
3. Inspect the monitor thoroughly for any damage that might have occurred during shipping.
4. If any damage to the monitor is found, report it immediately to your shipping carrier.

DO NOT RETURN DAMAGED MERCHANDISE TO THE MANUFACTURER UNTIL AN APPROPRIATE CLAIM HAS BEEN FILED WITH THE CARRIER AND A RETURN MATERIAL AUTHORIZATION NUMBER (RMA) HAS BEEN RECEIVED FROM THE MANUFACTURER.

GETTING STARTED

1. Plug the power cord into a wall receptacle or power strip that will accept this type of plug.
2. Attach an input/output video cable (*not included*) from the NTSC VIDEO RCA CONNECTOR or RF-NTSC CONNECTOR TYPE F in the rear panel of the monitor to a compatible connector on your video equipment.
3. See remote control for specific operation. (page 14)

Should further adjustment or alignment be necessary contact DOTRONIX, INC. customer service.

INSTALLERS MENU ADJUSTMENTS

To access the Installer's Menu, press and hold the MENU key until the User Menu display disappears, then press 9876, and then ENTER to access the Installer's Menu.

1390-04	2.08	01
Microcontroller Part Number	Program Revision	Font Revision
03HPos9	Factory Option	
Build Date	TE Status	
10/04/00	TE=10110000	

The black bar near the top of the screen indicates the part number of the software in the display. To the right is a number indicating that the module has been tested. The date on the black bar near the bottom of the screen indicates the date the module went through the factory.

When the Installer's menu appears, it displays the third Service Menu item: POWER MANAGE. Use the Up/ Down Arrow keys to toggle through all of the adjustments. Use Left/Right Arrows to make a change to the

00 FACT MENU: Use SELECT UP and DOWN Keys to select item 00, the Factory Mode. This item is used by the Factory when the module is being tested. It has two positions: 0 and 1. In the field, this item should always be left off (Zero is off).

When this item is off, only the first twenty-four items in the Installer's Menu can be accessed. They appear one at a time near the middle left of the screen. When this item is set to 1, 79 menu items are available.

In the Factory Menu, only the selected menu item is displayed, near the top of the screen, as shown in the figure above.

When the Factory Menu is on, the AC Power-On feature is always enabled regardless of the setting of AC ON in the Installer's Menu. The display will automatically come on when AC is applied.

Use the remote to reenter the Installer's Menu to turn the Factory Menu off. The Factory Mode may also be turned off by setting the clock, or running the Auto Program feature in the customer Set Up menu.

01 PRESET PX: Stores the video customer menu adjustments in the nonvolatile memory of the EAROM. Selections are Custom and Preset-Store. Settings for Contrast, Brightness, Color and Tint are stored in this manner. 0 is custom and 1 is Preset stored.

02 PRESET AX: Stores customer Audio menu adjustments in the nonvolatile memory of the EAROM. Selections are Custom and Preset-Store. Settings for Bass, Treble, Balance and SoundRite are stored in this manner. 0 is custom and 1 is Preset stored.

AVAILABLE MENUS

Your monitor is menu operated. In other words, adjustments to the monitor are made via a list of choices which appear on your monitor screen. To view these menus, press the MENU key on the remote control. Press MENU repeatedly to toggle through the available menus.

Setup Menu	Video Menu	Audio Menu
Auto Program Add/Del/Blink Ch. Labels Clock Set Caption/Text Language	Contrast Brightness Color Tint Sharpness Picture Pref	Bass Treble Balance Audio Mode Front Surr Soundrite Audio Pref

BASIC MENU OPERATION

The remote control buttons which are most frequently used for menu operations are shown here. In addition to these buttons, the number buttons may also be used where a number value is necessary, such as setting the time on the monitor.

Set Up Menu	Function
Auto Program	Finds and stores active channels with the CHANNEL Up/Down arrows.
Add/Del/Blink	Creates a list of favorite channels to use with CHANNEL Up/Down arrows.
Channel Labels	Assigns a network/station label, or call letters to channels. (Example: If you assign ABC to channel 13, then ABC will appear when you select channel 13.)
Clock Set	Sets the monitor's clock to the current time.
Caption/Text	Displays closed captions or text when available on the selected channel. Options are Off, Caption 1, Caption 2, Caption 3, Caption 4, Text 1, Text 2, Text 3, and Text 4.
Language	Displays a choice of three different languages, English, Spanish or French.

* No internal speakers supplied.

SPECIFICATIONS

- Horizontal Scan Rate: 15.75 kHz \pm 500 Hz
 - Vertical Sweep Rate: 60 Hz \pm 5%
 - Video Bandwidth: 6 MHz (-3db)
 - CRT Size: 27-inch
 - Resolution: 500 + lines
 - NTSC Video input through 75 ohm RCA connector
 - RF-NTSC connector type F
-
- Front Controls 27:
w/Remote Control/
Service Module
 - Brightness
 - Contrast
 - Color
 - Sharpness
 - Tint
 - Picture Preference
 - Rear Controls: Focus, Screen
 - Power requirements: 120 VAC \pm 10%, 60 Hz
 - Power consumption: 100 W nominal
 - Operating Temperature: 0°C to +45°C
(+32°F to +113°F)
 - Storage Temperature: (-17°C to +70°C)
(0°F to +158°F)
 - Cooling: Convection cooling will be adequate for most installations. Internal cabinet temperature **must not** exceed 55°C (131°F).
 - Stackability: Maximum recommended size is six units by six units without additional support.
 - Agency Approvals: UL, CUL, FCC Class A

MECHANICAL DIMENSIONS-CUBE

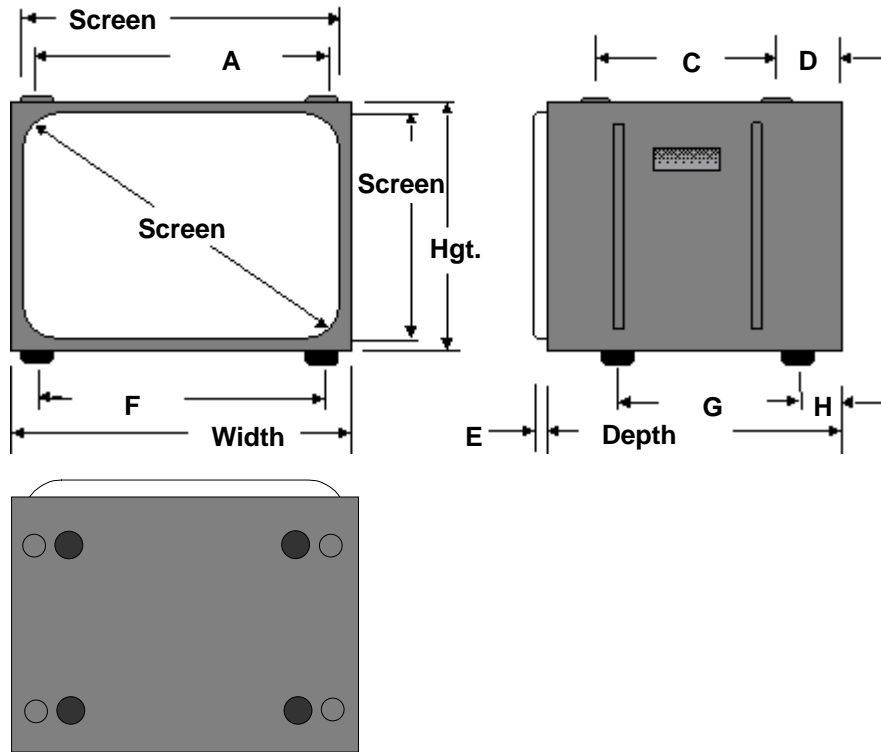

MECHANICAL DIMENSIONS UNIT = INCH (MM)

DIMENSION		27 INCH
HEIGHT		19.1 (486)
WIDTH		24.1 (613)
DEPTH		18.4 (467)
VIEWABLE	DIAG.	26.6 (675)
AREA	HORIZ.	21.3 (540)
	VERT.	15.9 (405)
STACKING	A	22.0 (559)
DIMPLE	C	12.0 (305)
LOCATIONS	D	3.4 (87)
CRT PROJECTION	E	1.8 (45.2)
FEET	F	20.5 (520.7)
(IF USED)	G	12.0 (305)
	H	3.4 (87)
WEIGHT		90 LBS. (41 kg)
SHIPPING		100 LBS. (45 kg)

REMOTE CONTROL

The following has been prepared to act as a guide in the operation of your REMOTE CONTROL input equipped monitors. Please read the following operating instructions carefully so that you are familiar with all of its features and capabilities before using your service module. All precautions and safety warnings should be read and strictly observed.

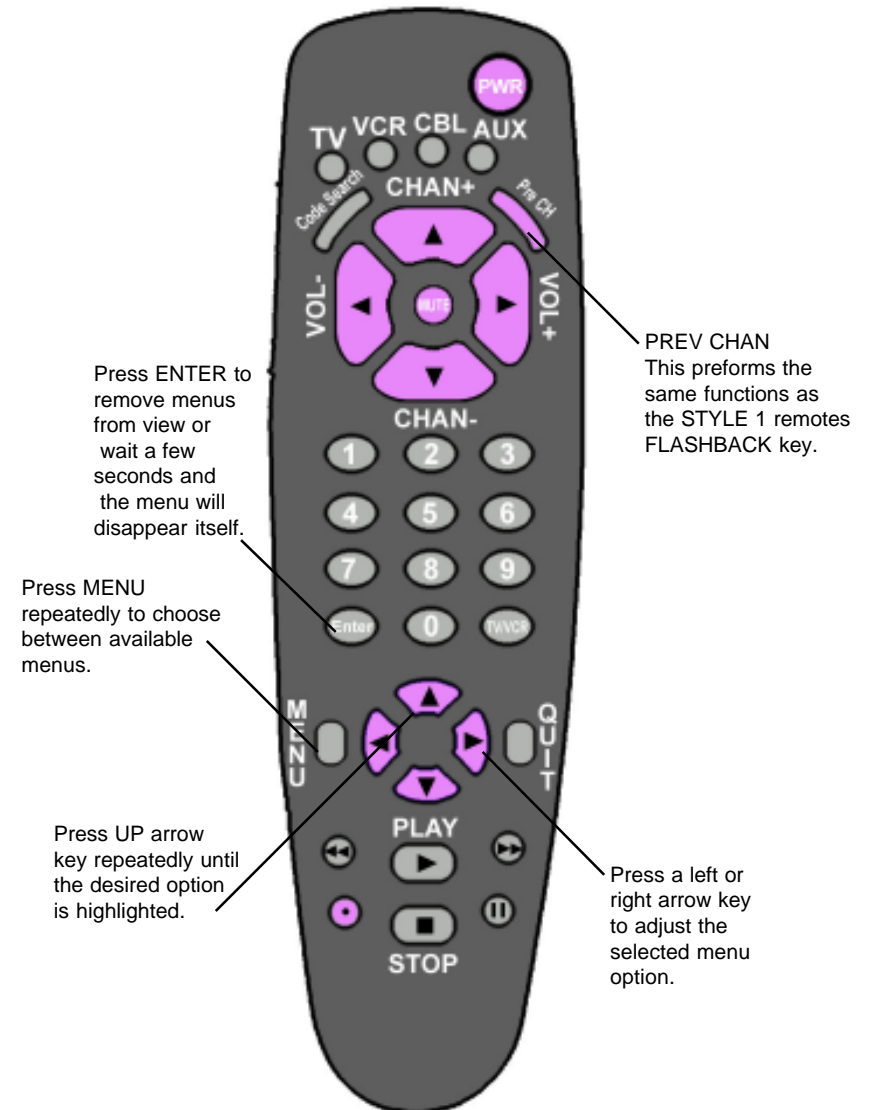

SERVICE MODULE INPUT W/ REMOTE CONTROL

Service Module input is in the front lower right bottom of bezel.

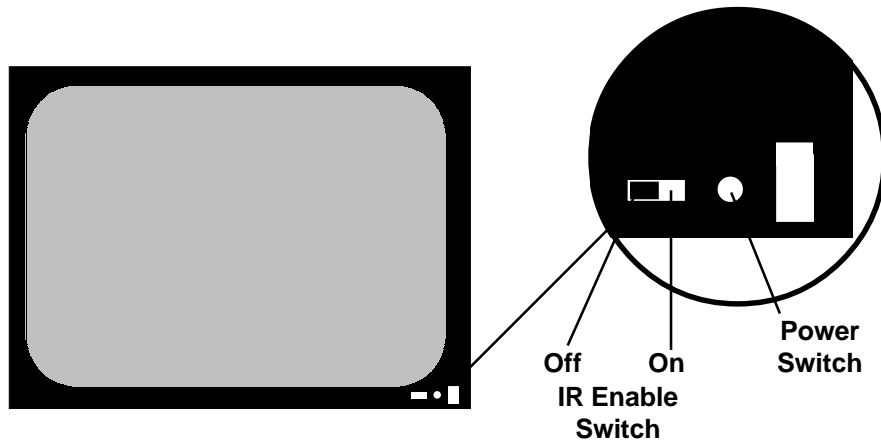

Note: Manual power switch is inactive with HARC option installed.

REAR CONTROLS DNR27

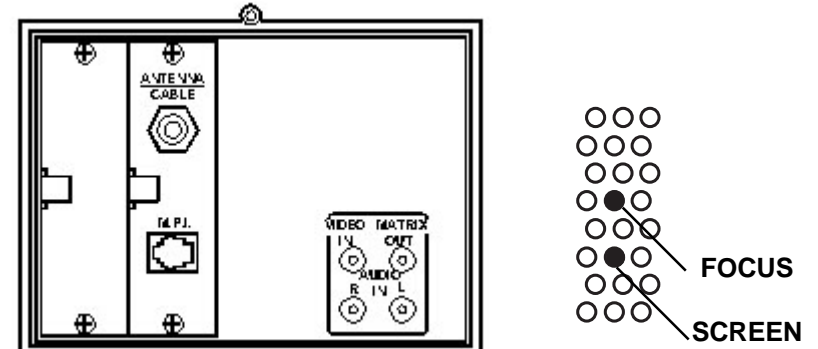

*** No internal speakers provided.**

CUSTOMER MENU

BRIGHTNESS	Adjusts the brightness level of black areas in the picture.
CONTRAST	Adjusts the overall contrast and color level of the picture.
COLOR	Adjusts the intensity of the colors in the picture.
SHARPNESS	Adjusts the definition of the object edges for best picture quality.
TINT	Adjusts the color of the flesh tones to more red or more green.
PICTURE PREF	Returns the display settings to their original factory settings.

NTSC VIDEO	• INPUT THROUGH RCA CONNECTOR
RF-NTSC	• CONNECTOR TYPE F
SCREEN DRIVE	• Adjusts thru vent holes.
FOCUS CONTROL	• Adjusts thru vent holes.

WALL INSTALLATIONS

Cooling: Convection cooling will be adequate for most installations. Internal cabinet temperature **must not** exceed 55°(131°F).

Stackability: Each monitor is enclosed in a heavy duty industrial metal cabinet. Maximum recommended stack size is six units by six units without additional support.

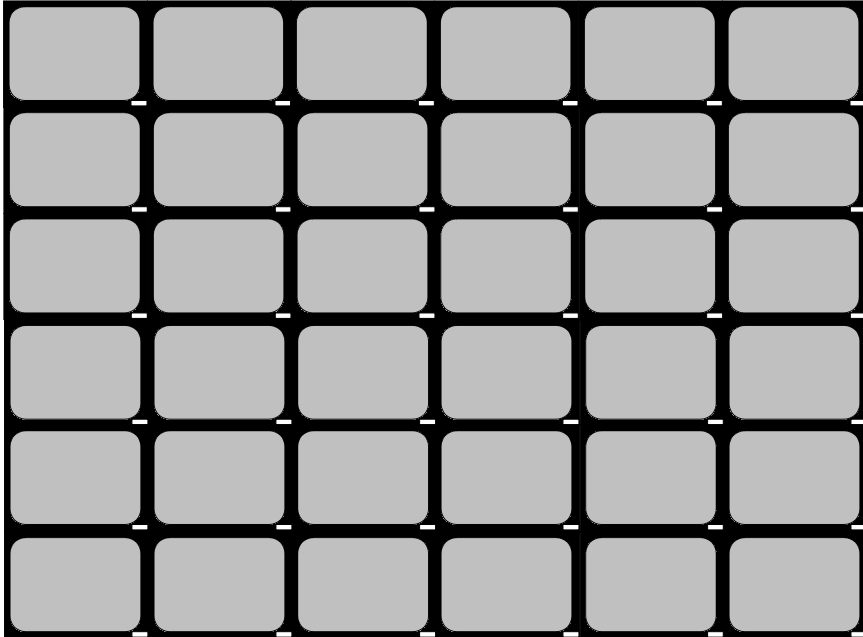

MOUNTING PLATE/ TIE BRACKET/CUBE

Order Part Number
13027526-007

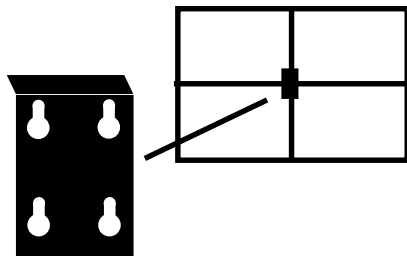

CRT COATINGS OPTION

As an option a factory installed anti-glare coating may have been applied to the CRT surface of your monitor. Due to static electricity, the monitor screen will attract dust and under normal use will acquire fingerprints. Recognizing that most people will touch the screen sooner or later causing these fingerprints, we recommend you implement a simple cleaning program. The anti-glare coating on your monitor is very durable and will stand up to routine cleaning. To prevent damage when cleaning, use a non-abrasive household glass cleaner to remove smudges and fingerprints. Do **not** use cleaners, papers, or cloths which contain abrasives that may damage the coating. Highly abrasive materials, scouring pads or acid solutions **should not be used**. Care must be taken when handling and cleaning this surface.

This monitor was inspected prior to shipment and found to meet Dotronix CRT coatings standard. The Dotronix warranty does not apply to CRT's that are scratched, or have imperfections in any special coatings.



Service Pack Contents